

P1=P3=P24=P25=P34

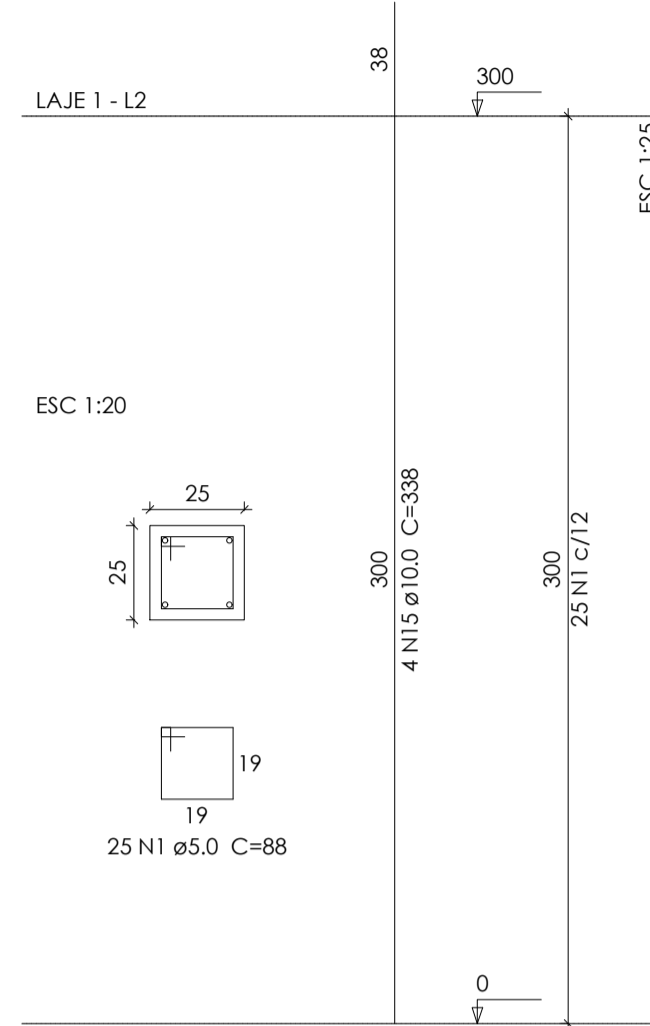

P11=P14=P22=P27=P31=P37

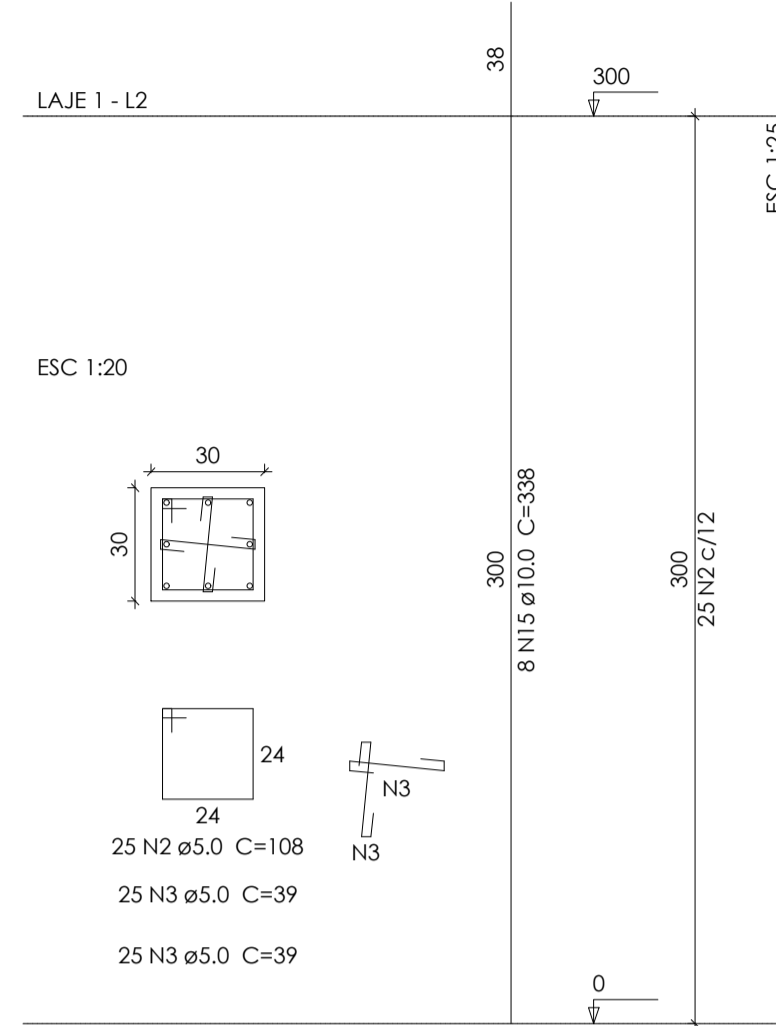

P12=P18

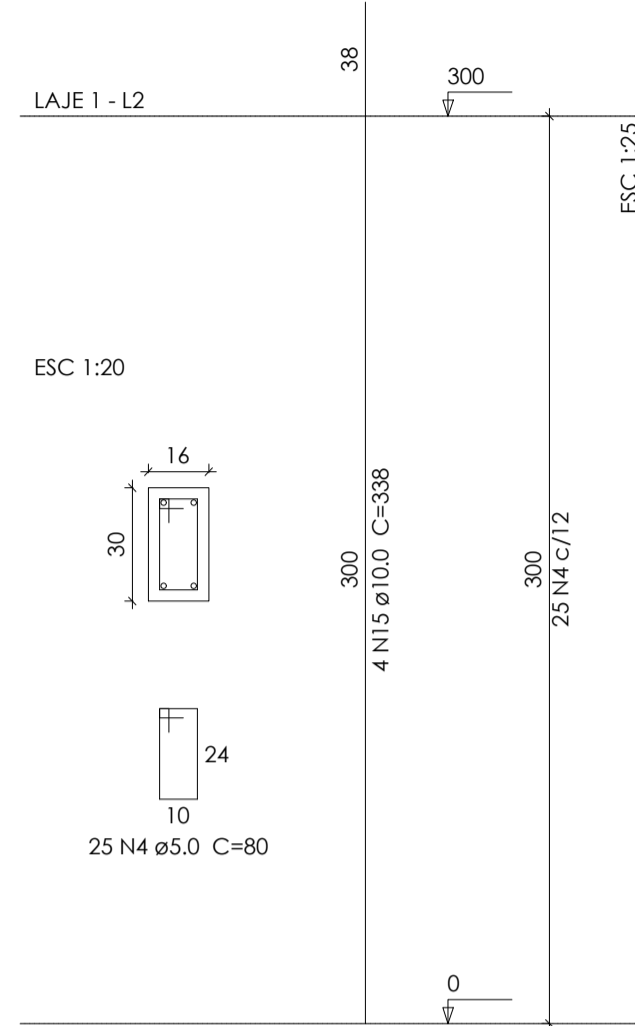

P13

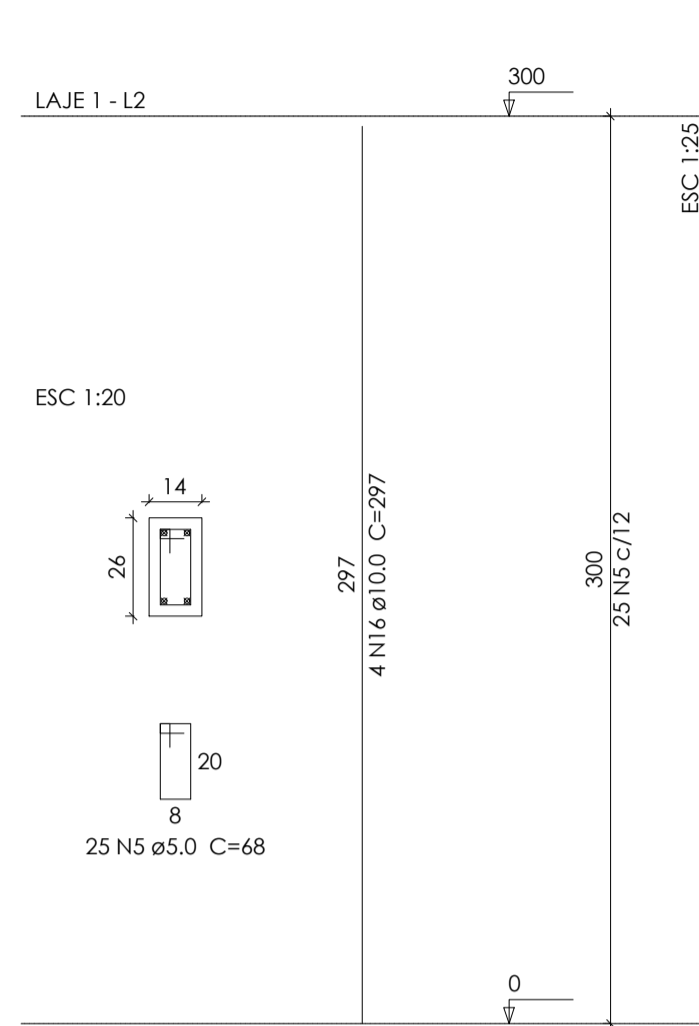

P15

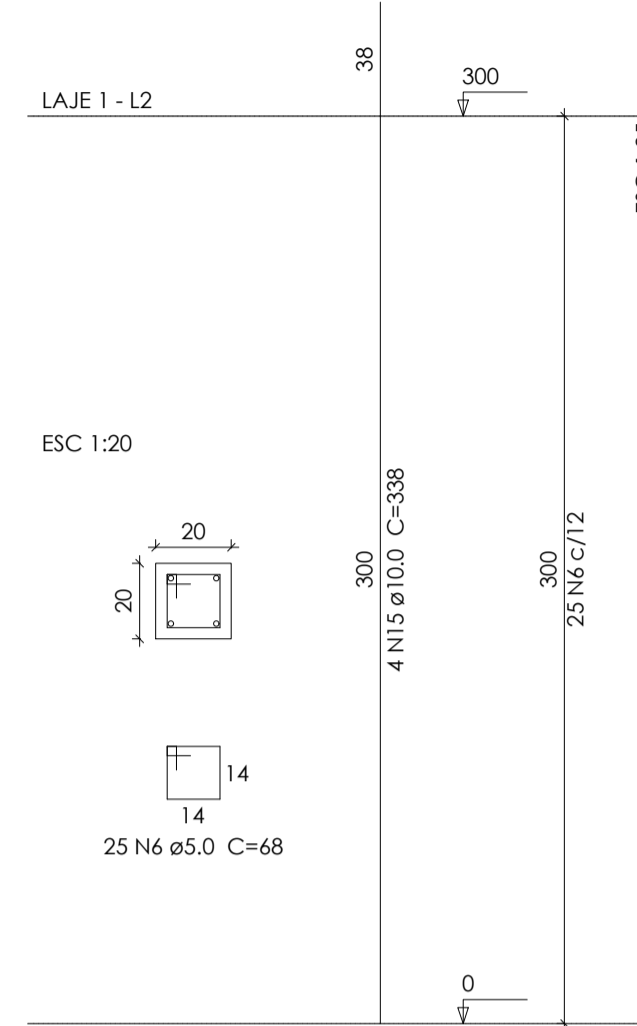

P2

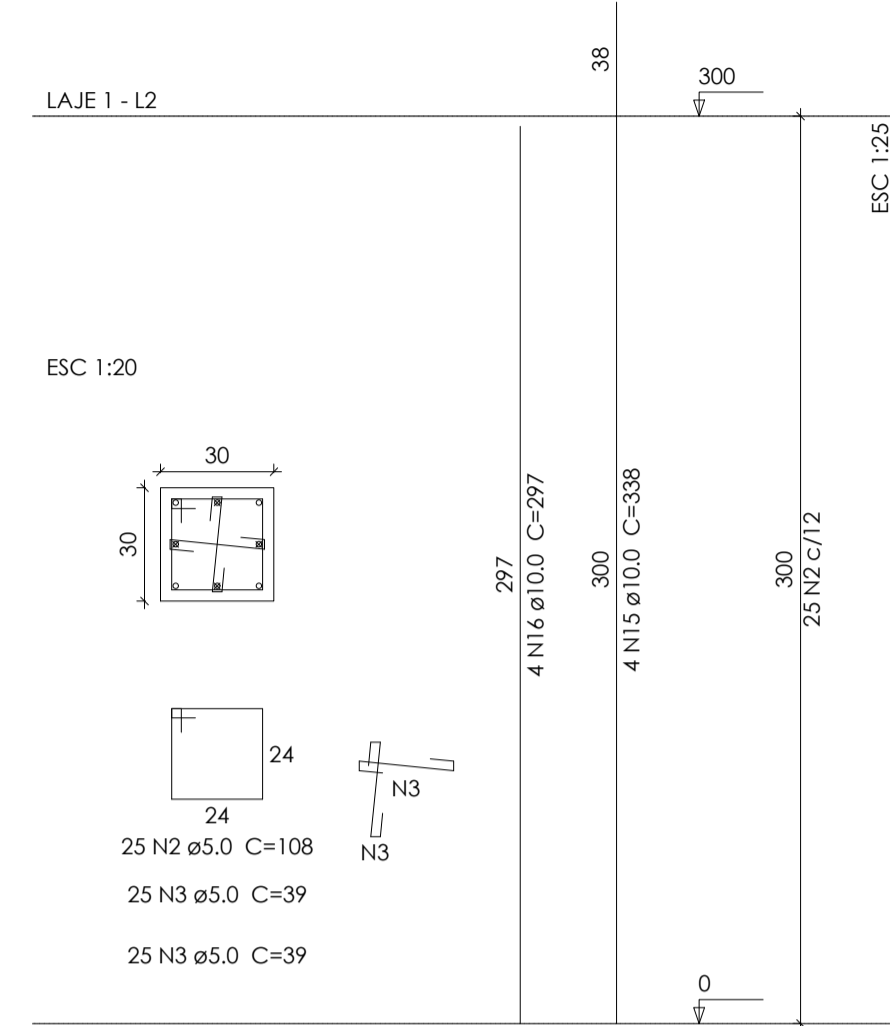

Relação do aço

AÇO	N	DIAM	Q	UNIT (cm)	C.TOTAL (cm)
CA60	1	5.0	175	88	15400
	2	5.0	200	108	21600
	3	5.0	350	39	13650
	4	5.0	50	80	4000
	5	5.0	50	68	3400
	6	5.0	50	68	3400
	7	5.0	68	148	10064
	8	5.0	136	49	6664
	9	5.0	100	76	7600
	10	5.0	25	84	2100
	11	5.0	200	70	14000
	12	5.0	25	78	1950
	13	5.0	25	104	2600
	14	5.0	150	72	10800
	15	10.0	192	338	64896
	16	10.0	12	297	3564
	17	12.5	20	347	6940
	18	12.5	4	94	376

Resumo do aço

AÇO	DIAM	C.TOTAL (m)	PESO + 10% (kg)
CA50	10.0	684.6	464.3
	12.5	73.2	77.5
CA60	5.0	1172.3	198.8
PESO TOTAL			
CA50			541.8
CA60			198.8

Vol. de concreto total (C-25) = 7.94 m³  
Área de forma total = 128.94 m²

P21=P43

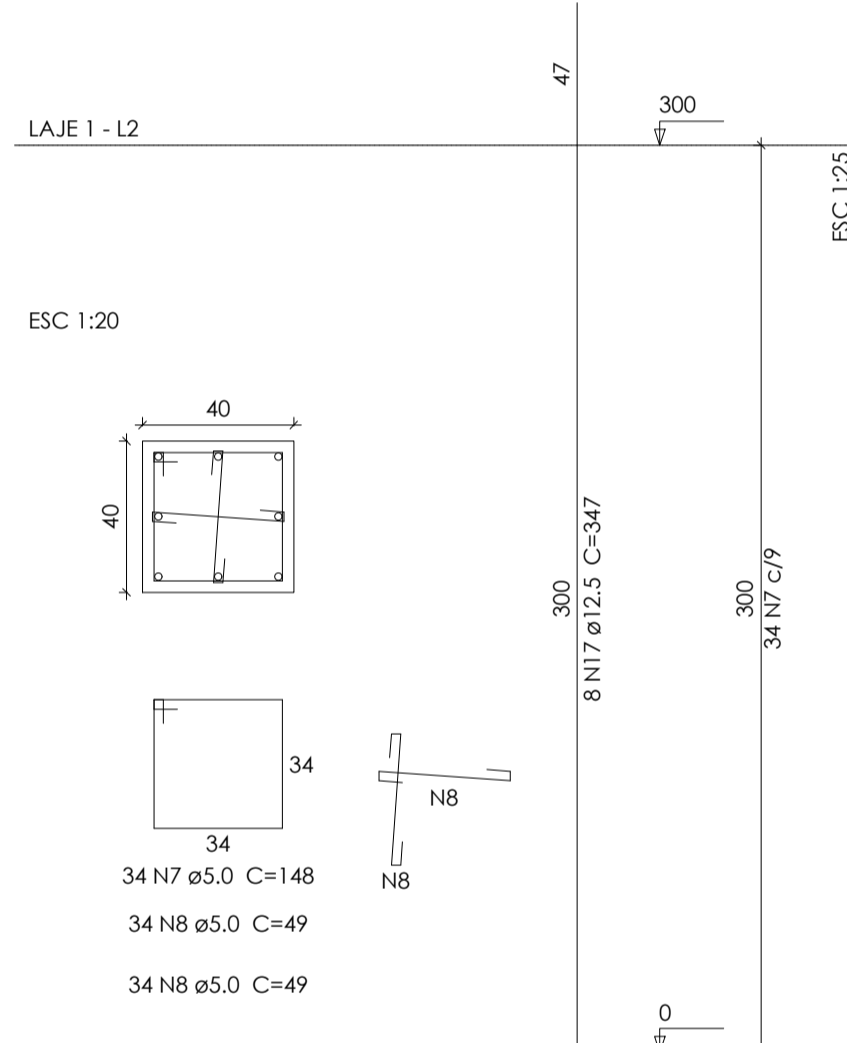

P23

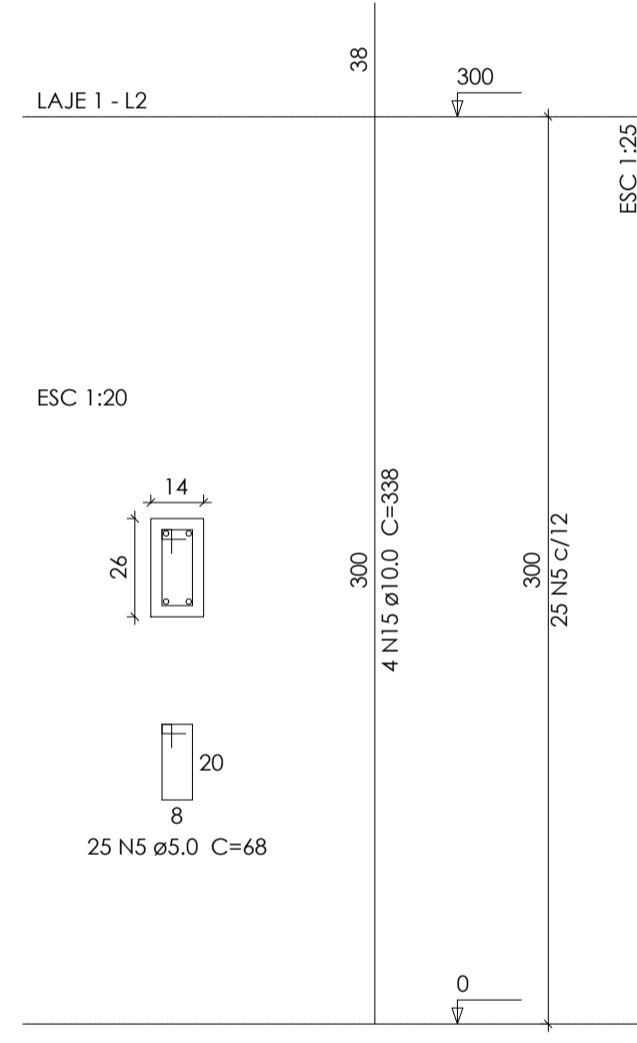

P28=P33

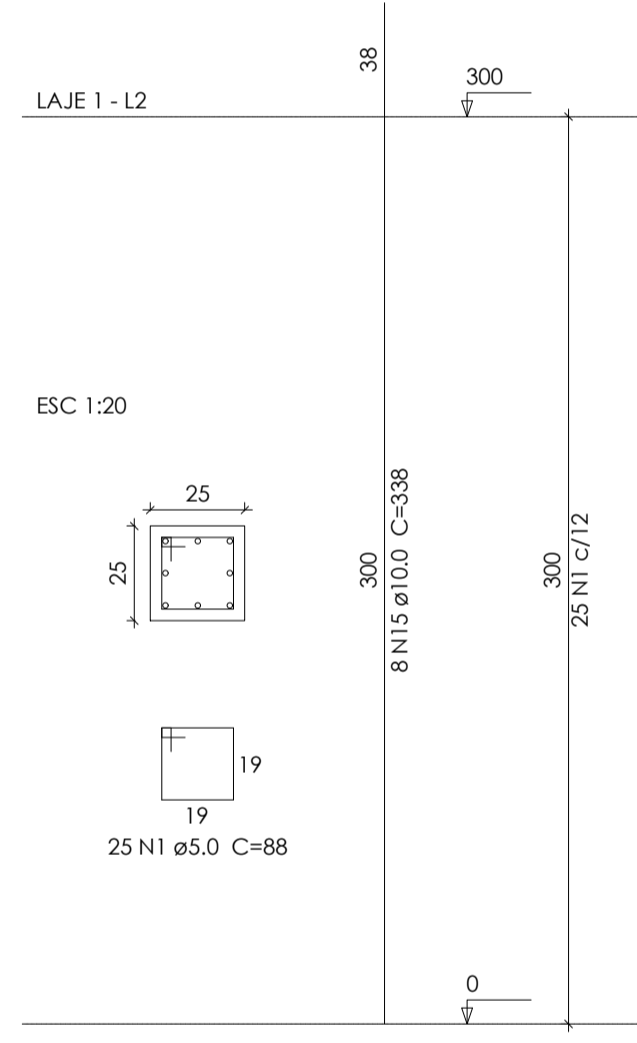

P29=P50=P52=P53

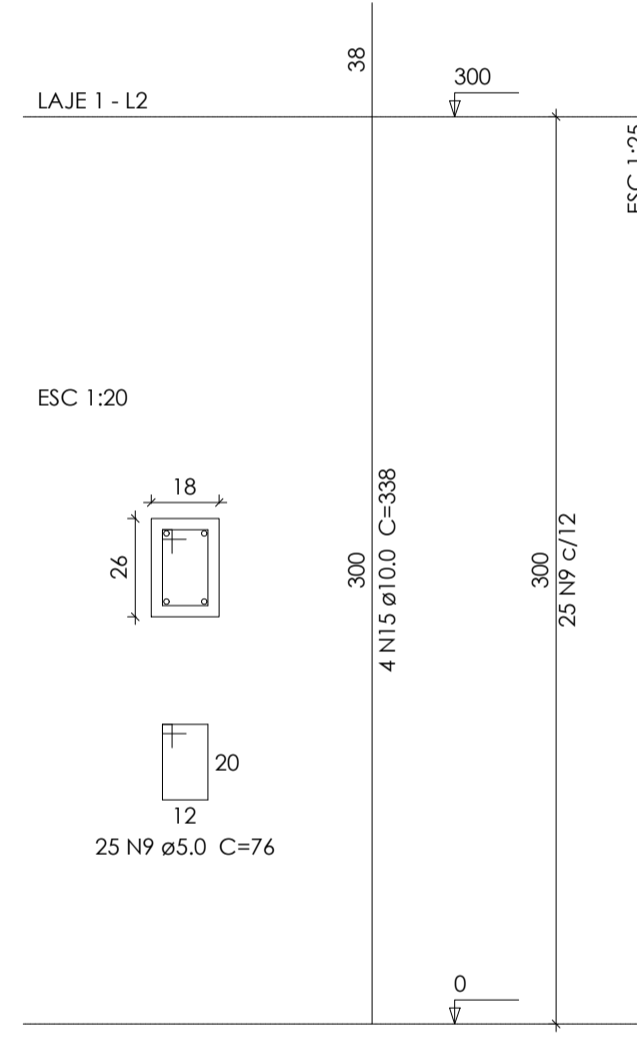

P38

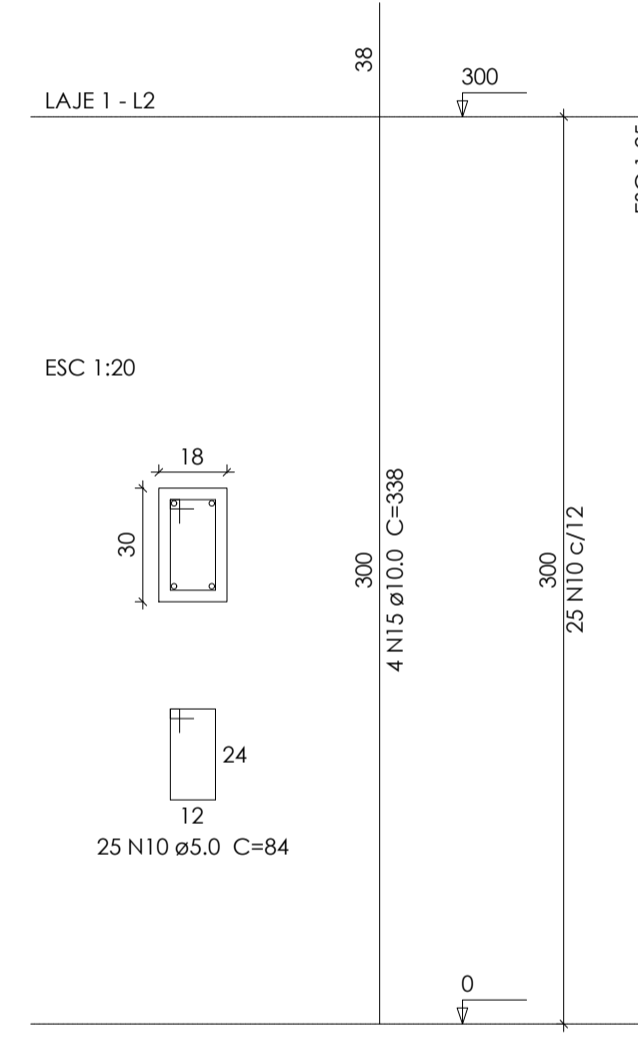

P39=P41

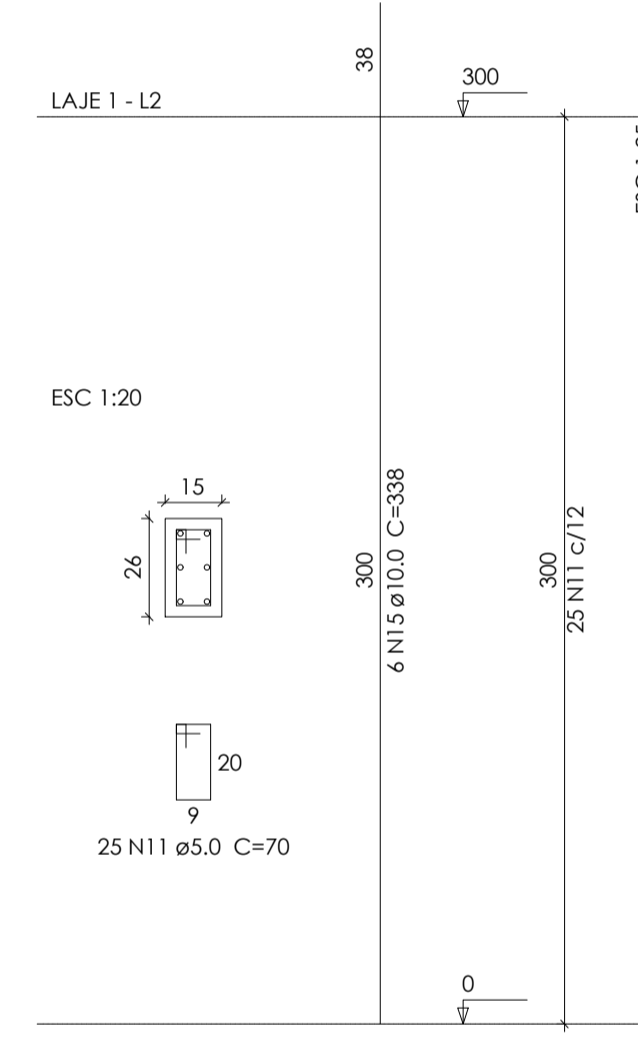

P42

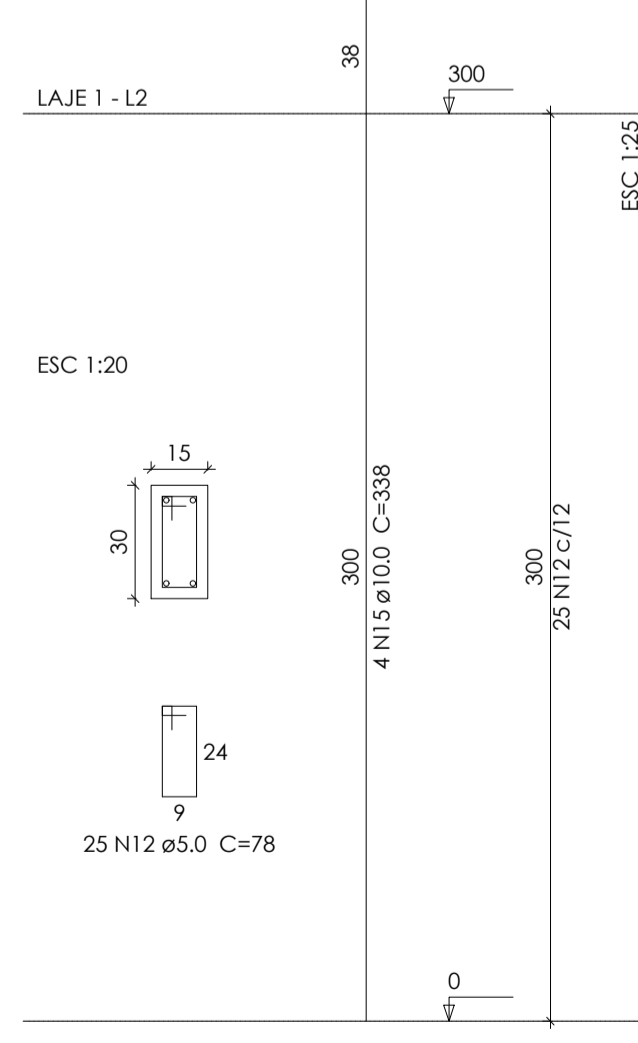

P44

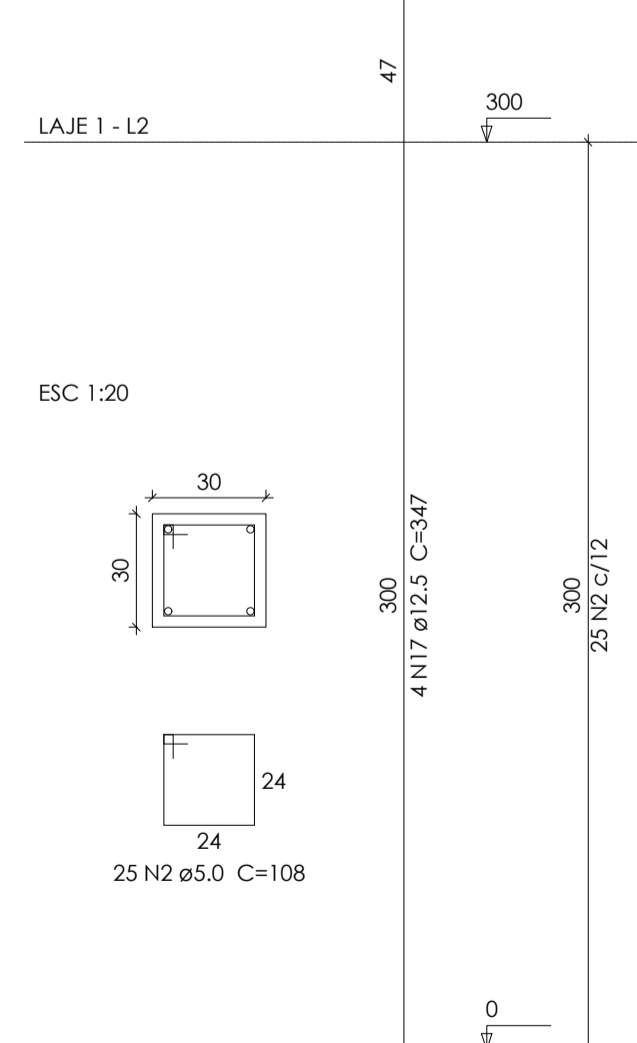

P45

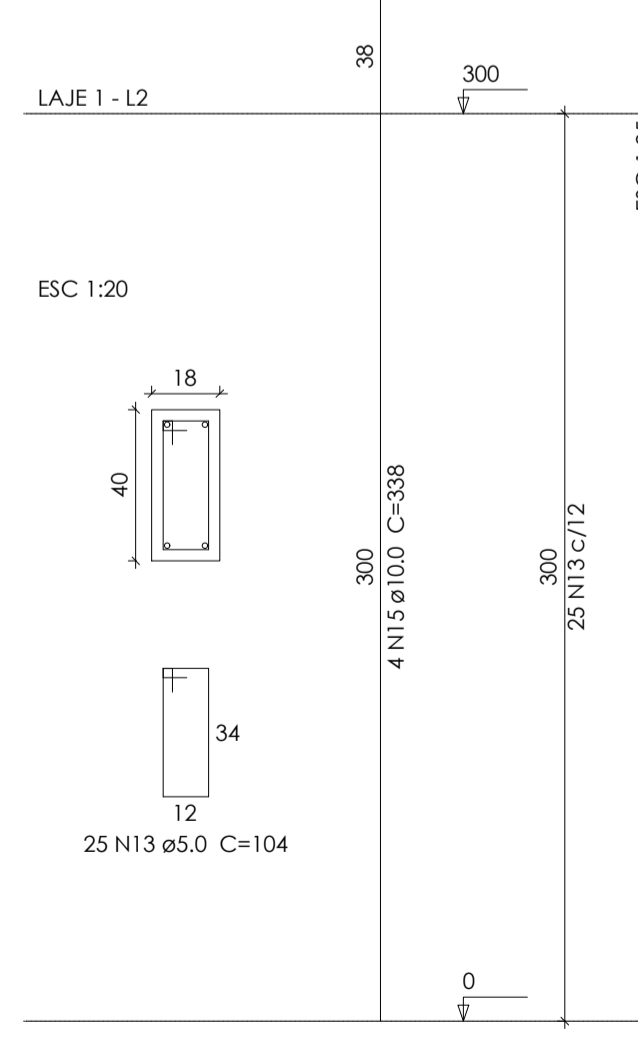

P47

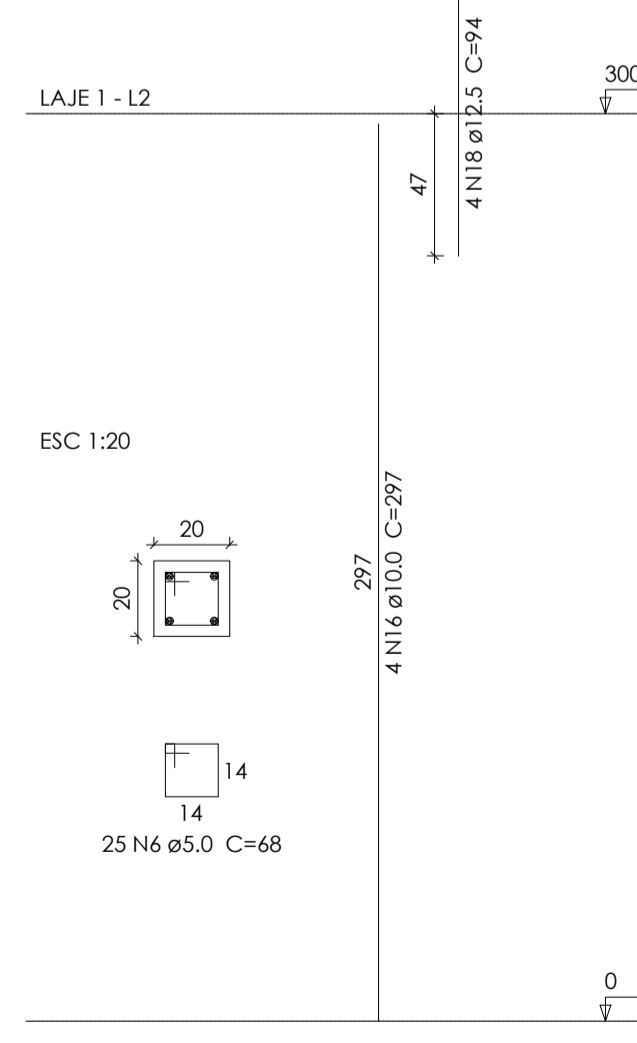

P5=P17=P26=P35=P40=P49

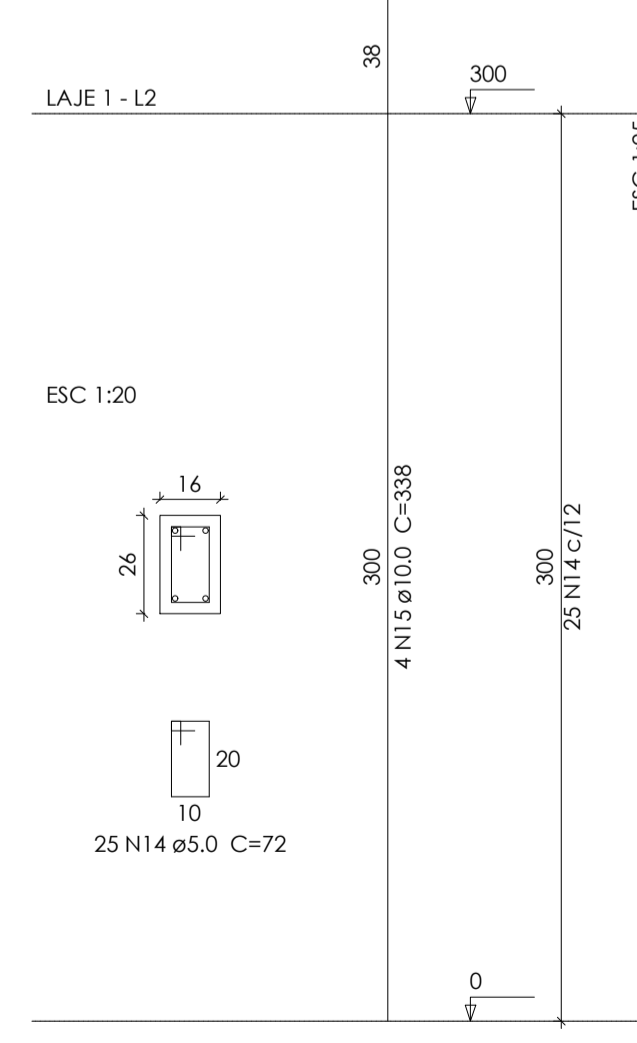

P6=P36=P46=P51=P54=P55

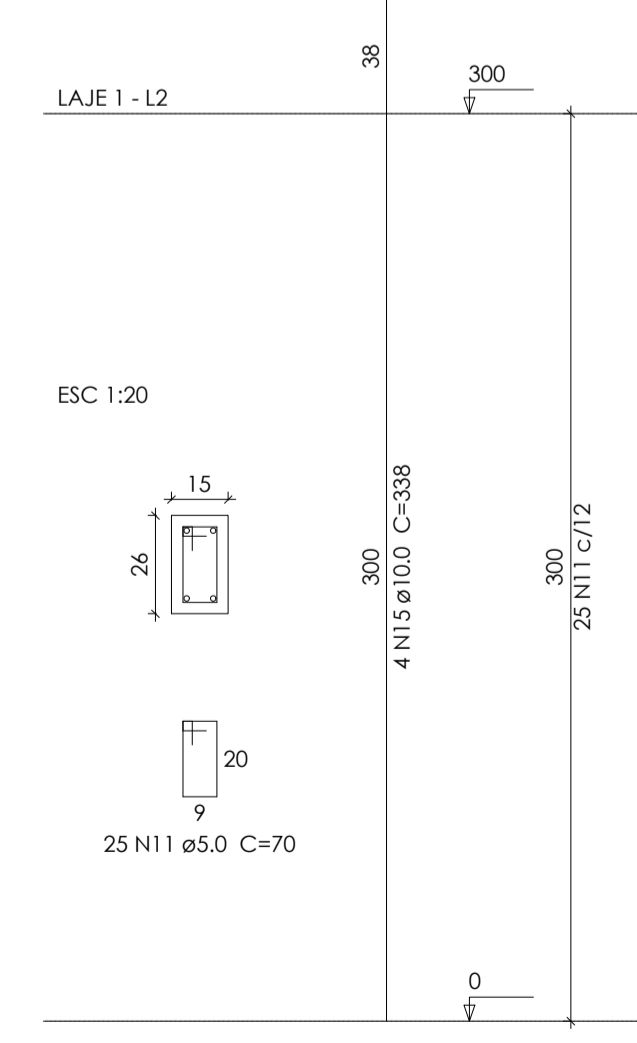



**FOCO**  
engenharia  
PROJETOS E EXECUÇÕES

TÍTULO:  
**Construção câmara de vereadores**

PROJETO:  
**Pilares pavimento laje 1**

FOLHA:  
**12/30**

DATA:  
**12/11/21**

---

**DADOS DO PROPRIETÁRIO(A):** MUNICIPIO DE PORTO DOS GAÚCHOS  
**ENDEREÇO DO PROPRIETÁRIO(A):** Praça Leopoldina Wilke 19, Centro - Porto dos Gaúchos - MT  
**CPF / CNPJ:** 03.204.187/0001-33  
**TELEFONE:** (66)3526-2000

---

**TIPO DA OBRA:** Construção comercial em alvenaria, forro de gesso e cobertura isotérmica

---

**ASSINATURAS:**

AUTOR DO PROJ.:  
Evelin Luani Montagna  
Engenheira Civil  
Crea-MT: 039125

RESP. TÉCNICO:  
Evelin Luani Montagna  
Engenheira Civil  
Crea-MT: 039125

PROPRIETÁRIO(A):  
Município de Porto dos Gaúchos  
CNPJ: 03.204.187/0001-33